



BedRock

FENCES | GATES | BALCONY | MORE

2025 Collection



BedRock

Product Catalog

2025

Our Mission & Vision

At BedRock Metals, we believe that industry- scale transformation begins with innovation. Unlike traditional players in the aluminum industry, we challenge the status quo by blending advanced fabrication technology with forward-thinking design & manufacturing processes. Our mission is to revolutionize how aluminum products are manufactured and delivered—offering unmatched precision, customization, and quality. By redefining standards in a historically stagnant industry, we aim to drive economic growth, modernize infrastructure, and shape a more sustainable, resilient future for construction and manufacturing.



Fences



Safe, Sleek & Secure



Our fences are engineered to provide the highest level of safety without compromising on style. Crafted from premium-grade aluminum, each fence combines sleek, modern designs with robust construction to protect your property and loved ones. With corrosion-resistant materials and precision fabrication, BedRock Metals fences stand strong against the elements and potential intruders—giving you peace of mind with unmatched durability and elegance.

Our Fences

Crafted with precision and built from premium-grade aluminum, our fences offer exceptional durability, weather resistance, and a sleek, modern finish—ensuring long-lasting performance with minimal maintenance for residential, commercial, and industrial applications.

Color Options

-  Black
-  White
-  Bronze
-  Silver
-  Custom

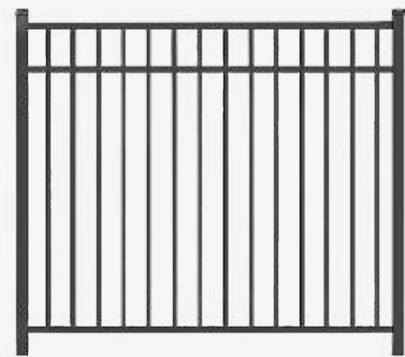

3 Rail Fence

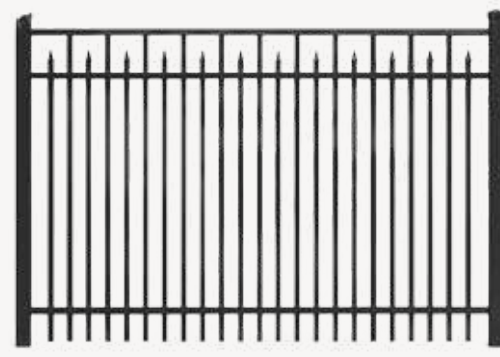

Flat Top with Spear Fence

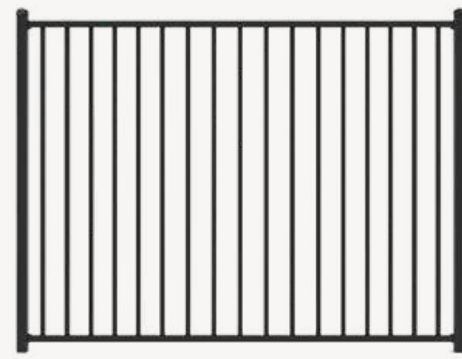

2 Rail Fence



Spear Top Fence

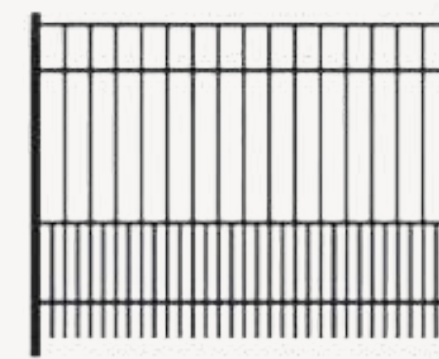

Puppy Picket Fence

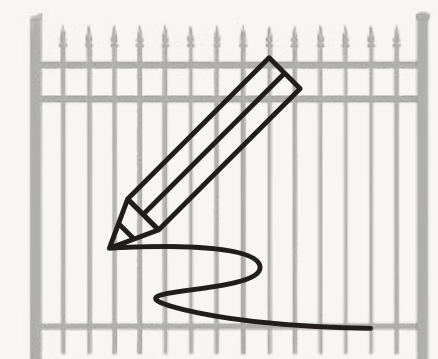

Your Custom Design



Spear Top Fence

This spear-top fence is engineered not only for elegance and strength but also with safety in mind. Its smooth, contoured edges and rounded spear design reduce sharp contact points, making it cut-safe and safer for children and pets compared to traditional pointed styles.

Child & Pet Friendly: The spear top is gently tapered without sharp spikes, minimizing injury risks during play or contact.

Cut-Safe Geometry: No exposed burrs or razor edges—each profile is finished with precision to eliminate surface hazards.

Durable & Impact-Resistant: Crafted from high-strength aluminum or steel, the fence resists bending or snapping under force, ensuring long-term safety and reliability.

Tamper-Resistant Mounting: Secured with hidden fasteners or welds to prevent accidental dislodging or tampering by kids or animals.

Non-Toxic Coatings: Finished with a powder-coated, lead-free surface that's safe to touch and resistant to weathering or flaking.”



Custom Aluminum Accessories

Your Vision, Our Craftsmanship

In addition to the premium accessories featured on this page, we're excited to offer custom solutions tailored to your unique needs. Whether it's a bespoke design or a one-of-a-kind accessory to complement your space.

Color Options



Chess Pawn Post Cap



Bishop Post Cap



Butterfly Accessory



Fleur-De-Lis Accessory



Rings Accessory

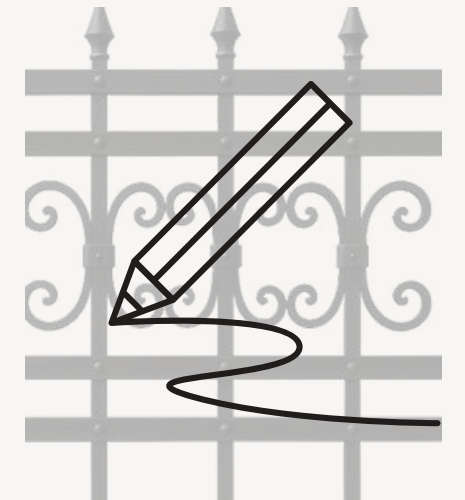

Custom Cast Aluminum Accessory



Item	Residential	Commercial	Industrial
Pickets	5/8" sq. x .050" wall thickness	3/4" sq. x .055" wall thickness	1" sq. x .062" wall thickness
Rails (Top Wall)	1-1/8" x 1" x .062" wall	1-3/8" x 1-1/4" x .065" wall	1-5/8" x 1-5/8" x .070" wall
Rails (Bottom Wall)	1-1/8" x 1" x .080" wall	1-3/8" x 1-1/4" x .088" wall	1-5/8" x 1-5/8" x .100" wall
Standard Post	2" sq. x .060" or .080" wall	2-1/2" sq. x .100" wall	3" sq. x .125" wall
Gate Posts	2" sq. x .125" wall	2-1/2" sq. x .125" wall	3" or 4" sq. x .125" wall
Picket Spacing	Standard: 3- 13/16"; Optional: 1- 5/8"	Standard: 3-5/8"; Optional: 1- 1/2"	Standard: 4"; Optional: 1-1/2"
Post Spacing	72" on center (2" posts)	72"-96" on center (2.5" posts)	96" on center (2.5" posts)
Heights	36", 42", 48", 54", 60", 72"	48", 54", 60", 72"	48", 60", 72", 84", 96", 108"
Panel Size	6' wide; rackable up to 12"	6'-8' wide; rackable up to 24"	6'-8' wide; rackable up to 24"

Gates



Exceptional Quality, Timeless Durability



At BedRock Metals, our gates are more than just entryways—they're a statement of strength and style. Crafted from top-tier aluminum with meticulous attention to detail, our gates deliver exceptional quality that stands the test of time. Engineered for durability and designed to withstand the harshest conditions, each gate combines functionality with timeless aesthetics, ensuring your property remains secure and visually striking for years to come.

Our Gates

Our aluminum gates are crafted with precision and built to endure. Designed to resist rust, corrosion, and harsh weather conditions, they maintain their strength and beauty year after year. Using top-grade materials and expert fabrication techniques, we ensure every gate delivers unmatched durability and reliability, all while adding a touch of elegance to your property. Choose our aluminum gates for a solution that combines superior craftsmanship with long-lasting performance because quality should stand the test of time.

Color Options

-  Black
-  White
-  Bronze
-  Silver
-  Custom



Regal Crest Gate

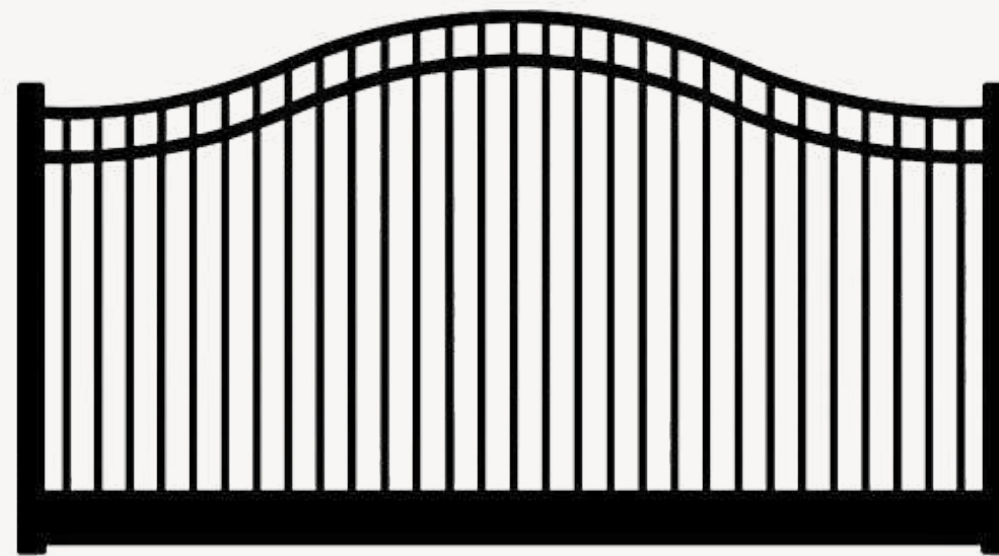

Arcadian Elegance Gate

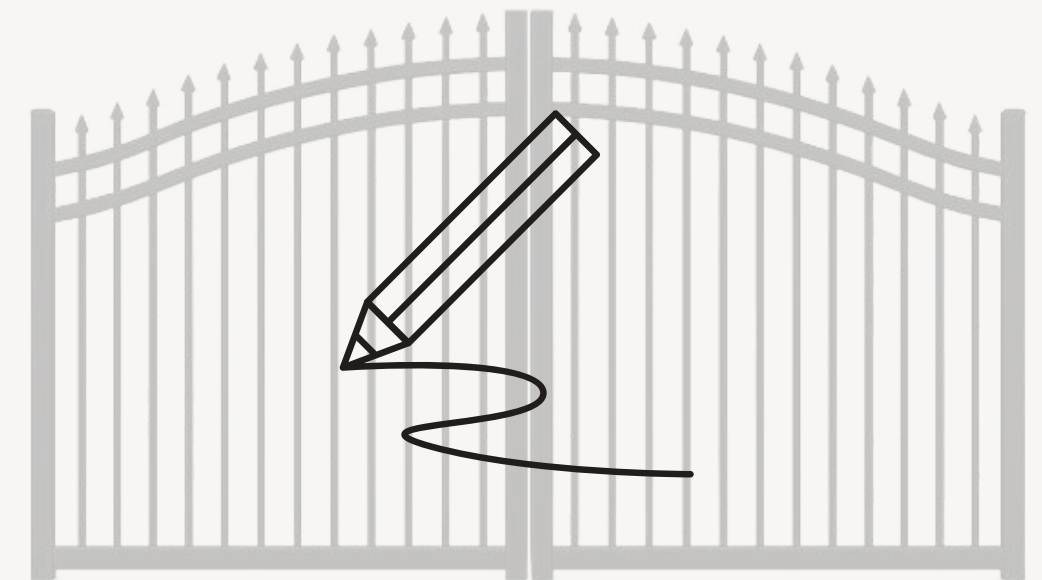

Your Custom Design



Item	Residential	Commercial	Industrial
Gate Frame	2''w(.125)×1''h(.125)	2''w(.125)×1''h(.125)	2''×3''×.125''
Pickets	5/8''Sq×.045	3/4''Sq×.062	Varies by Gate Opening
Rails (Top Wall)	1''Sq×.062	2''w(.125)×1''h(.125)	2''×3''×.125''
Rails (Bottom Wall)	2''×2''×.090	2''×2''×.090	2''×2''×.125
Gate Heights	36", 42", 48", 54", 60", 72"	36", 42", 48", 54", 60", 72"	36", 42", 48", 54", 60", 72", 84", 96"
Gate Widths	Varies by Gate Opening	Varies by Gate Opening	Varies by Gate Opening
Flat Bar	1/4" x 5"	1/4" x 5"	1/4" x 5"
Post Dimensions	2''×2''×.063	2-1/2''×2-1/2''×.075	4''Sq×.125'', 4''Sq×.250'', 6''Sq×.125'', 6''Sq×.250''
Finish Options	AAMA 2604 powder certified	AAMA 2604 powder certified	AAMA 2604 powder certified
Cantilever System	Not specified	Not specified	Not specified
Picket Spacing	Standard: 4-1/2'' o/c (3-7/8'' btw); Double Picket: 2-1/4'' o/c (1-11/16'' btw)	Standard: 4-5/8'' o/c (3-7/8'' btw); Double Picket: 2-5/16'' o/c (1-9/16'' btw)	Standard: 4-7/8'' o/c (3-7/8'' btw); Double Picket: 2-7/16'' o/c (1-7/16'' btw)



Balcony & Railing

Premium Quality Meets Endless Customization



At BedRock Metals, we don't just manufacture aluminum products — we craft solutions tailored to your vision. Combining premium materials with expert craftsmanship, our products deliver unmatched durability and performance. Whether it's fences, gates, railings, or architectural panels, our advanced fabrication techniques allow for endless customization options to perfectly suit your project's unique needs and style. Experience the perfect blend of strength, beauty, and flexibility with BedRock Metals.

Our Balcony & Railing

Our aluminum railings are designed to combine unmatched durability with stunning aesthetics. Crafted from high-grade aluminum, they are resistant to rust, corrosion, and wear, ensuring long-lasting performance in any environment. What sets us apart is our commitment to customization. Whether you envision sleek modern lines, classic designs, or intricate ornamental patterns, we work with you to create railings that perfectly match your style and space. Choose our aluminum railings for a solution that offers superior strength, low maintenance, and the freedom to bring your unique ideas to life. Your vision, our craftsmanship

Color Options

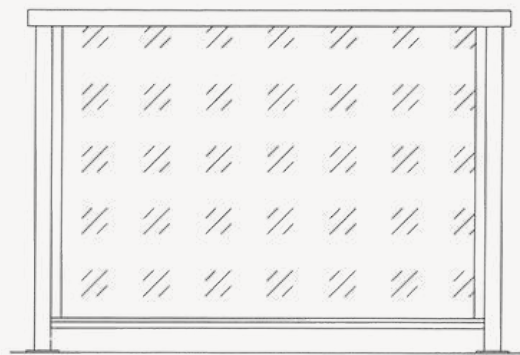

Glass Railing



Horizontal Slat Railing



Picket Railings (Vertical Bars)



Cable Railing

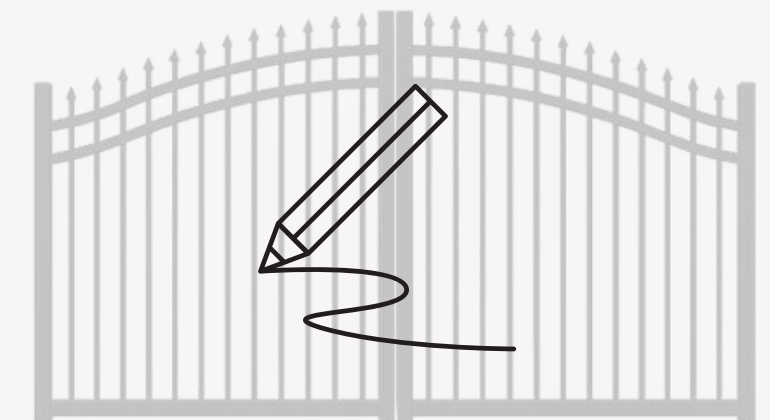

Your Custom Design



Balcony & Railing Measurements

The following measurements represent our standard sizes; however, custom profile sizes are also available upon request.

Balcony & Railing Measurements

Height	Width	Gate Widths
4", 5"	6"	Single: 4", 5"

Railing Measurements

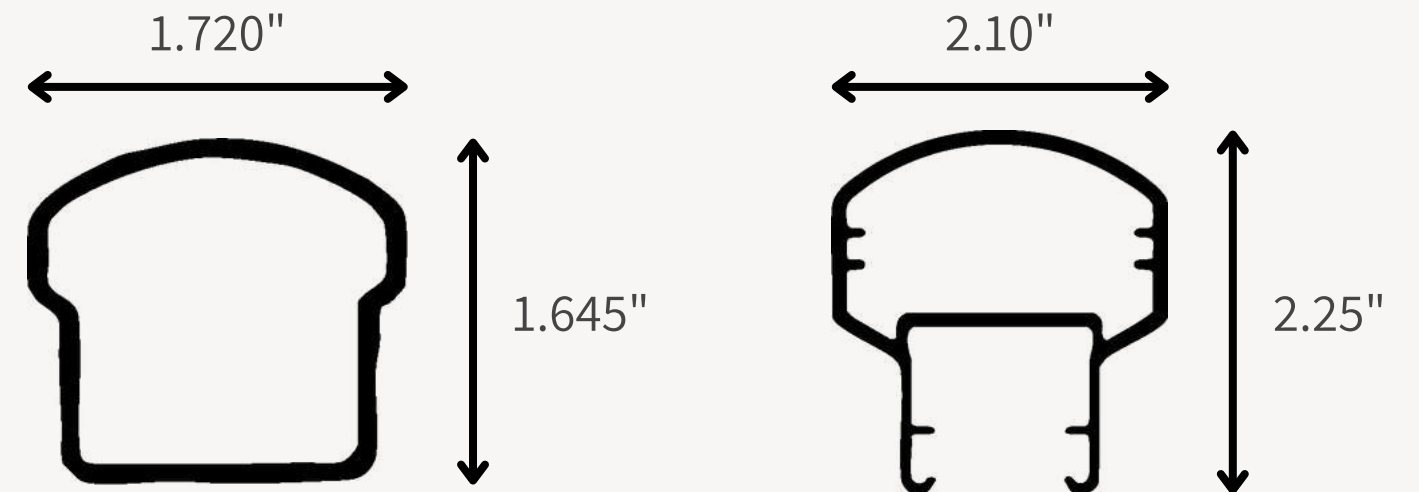

Railing Measurements

Railing Type	Rail Diameter	Available Lengths	Attachments	Hardware	Colors Available
Light Aluminum Railing	1.5" (3.81 cm)	4' (122 cm), 6' (183 cm), or 8' (244 cm)	(2) 90-degree wall returns, 8' includes additional middle mount	Wall mounts with wood fasteners	White, Black
Straight Aluminum Railing	1.5" (3.81 cm)	4' (122 cm), 6' (183 cm), or 8' (244 cm)	(2) wall mounts, 8' includes additional middle mount	Wall mounts with wood fasteners	White, Black



Balcony & Railing Accessories

The following measurements represent our standard sizes; however, custom profile sizes or designs are also available upon request.



End Post



Line Post



Corner Post



Gate End Post



Gate Blank Post

Post Measurements

Product Name	Components Included	Size Options
Light Aluminum Railing Post Kit	Post cap, 1-piece post skirt and base flange (fasteners not included)	• 2.5" × 2.5" × 39" • 2.5" × 2.5" × 45" • 2.5" × 2.5" × 54"
Heavy Aluminum Railing Post Kit	Post cap, 2-piece post skirt and base flange (fasteners not included)	• 3" × 3" × 39" • 3" × 3" × 45" • 3" × 3" × 54"



Secondary (ADA) Aluminum Railing

The following measurements represent our standard sizes; however, custom profile sizes or designs are also available upon request.

Wall Return Aluminum Railing

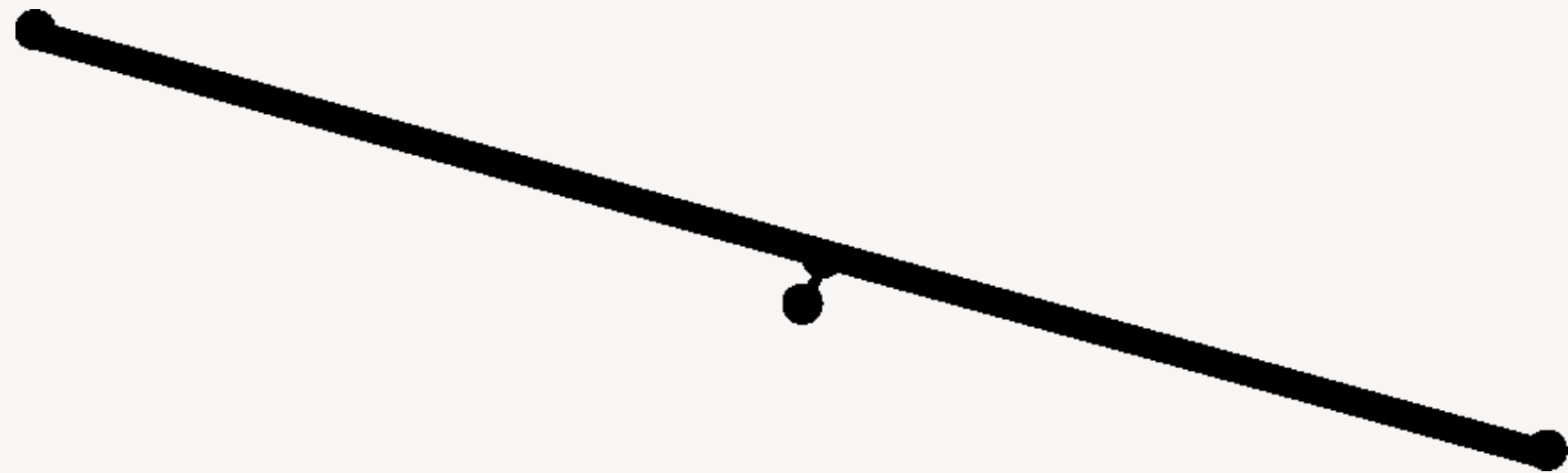



Rail: 1.5" diameter

Length: 4", 6" or 8"

Attachment: (2) 90-degree wall returns,
8" includes additional middle mount

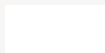
Hardware: Wall mounts with wood fasteners

Color:  Black  White  Custom

Straight Aluminum Railing

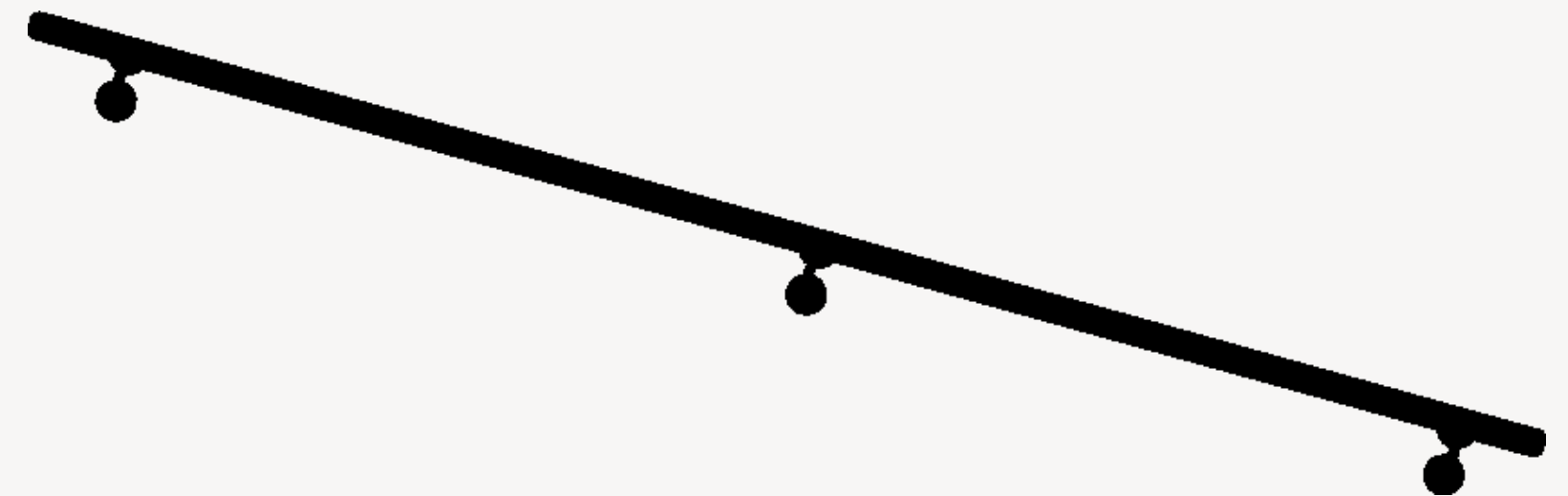



Rail: 1.5" diameter

Length: 4", 6" or 8"

Attachment: (2) wall mounts,
8" includes additional middle mount

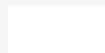
Hardware: Wall mounts with wood fasteners

Color:  Black  White  Custom





Louvered

Strong, Stylish & Secure

Combining robust construction with sophisticated design, our louvered panels provide a secure barrier that enhances privacy and withstands harsh conditions. Engineered for strength and crafted with a keen eye for aesthetics, they offer a contemporary, stylish solution that complements both residential and commercial projects.



Louvered Privacy Panels

Louvered Privacy Panels offer a sleek and durable solution for creating private outdoor spaces, available in 6' wide sections with heights of 4', 5', or 6'. Designed to provide 100% visual privacy at level sight lines, the panels feature a 145-degree louver angle that blocks direct views while allowing natural airflow. Constructed from high-strength aluminum alloy, they are as strong as steel yet completely rustproof, ensuring long-lasting performance with minimal maintenance. Ideal for both residential and commercial applications, these panels combine privacy, ventilation, and modern design in one versatile system.

Color Options

-  Black
-  White
-  Bronze
-  Silver
-  Custom

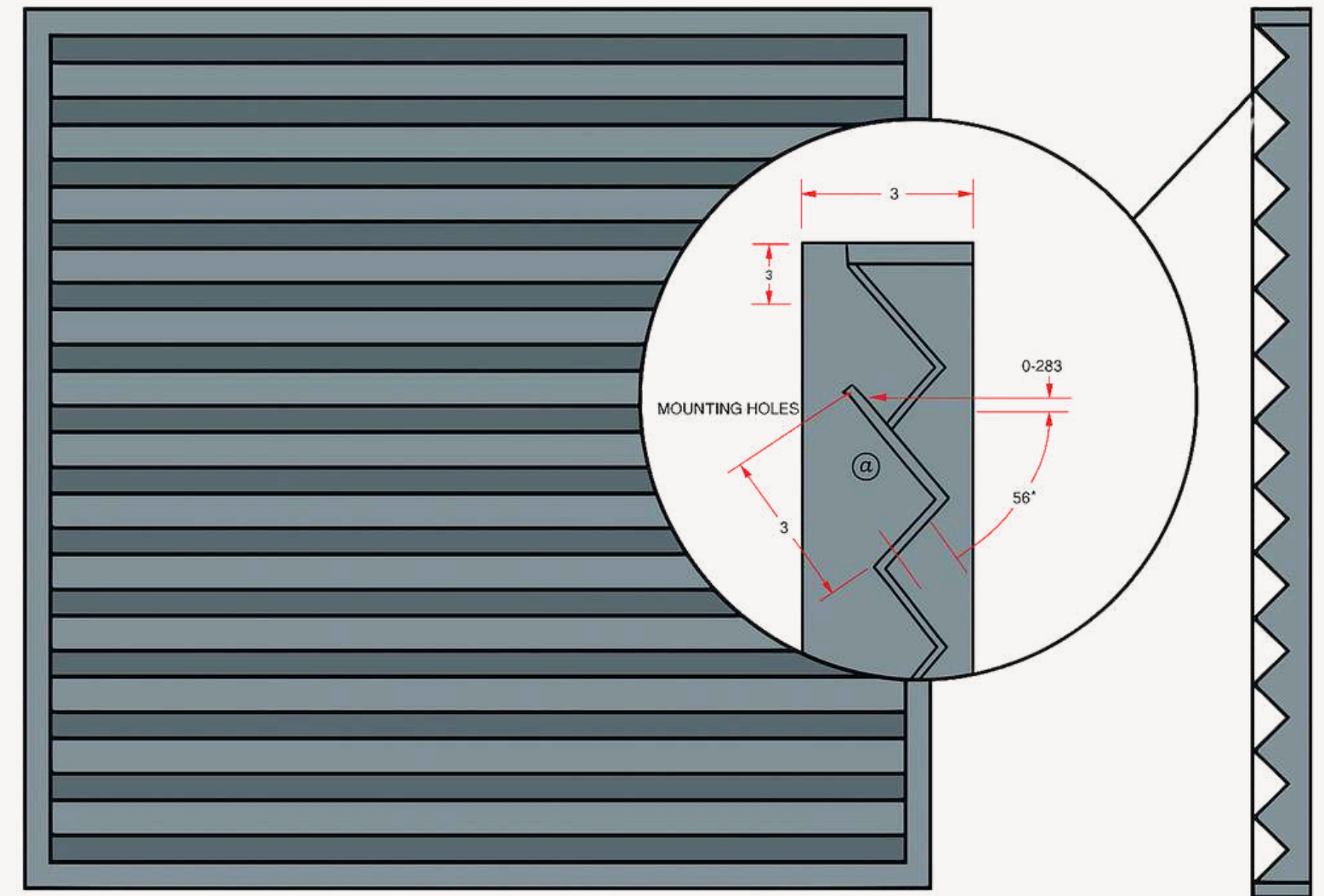
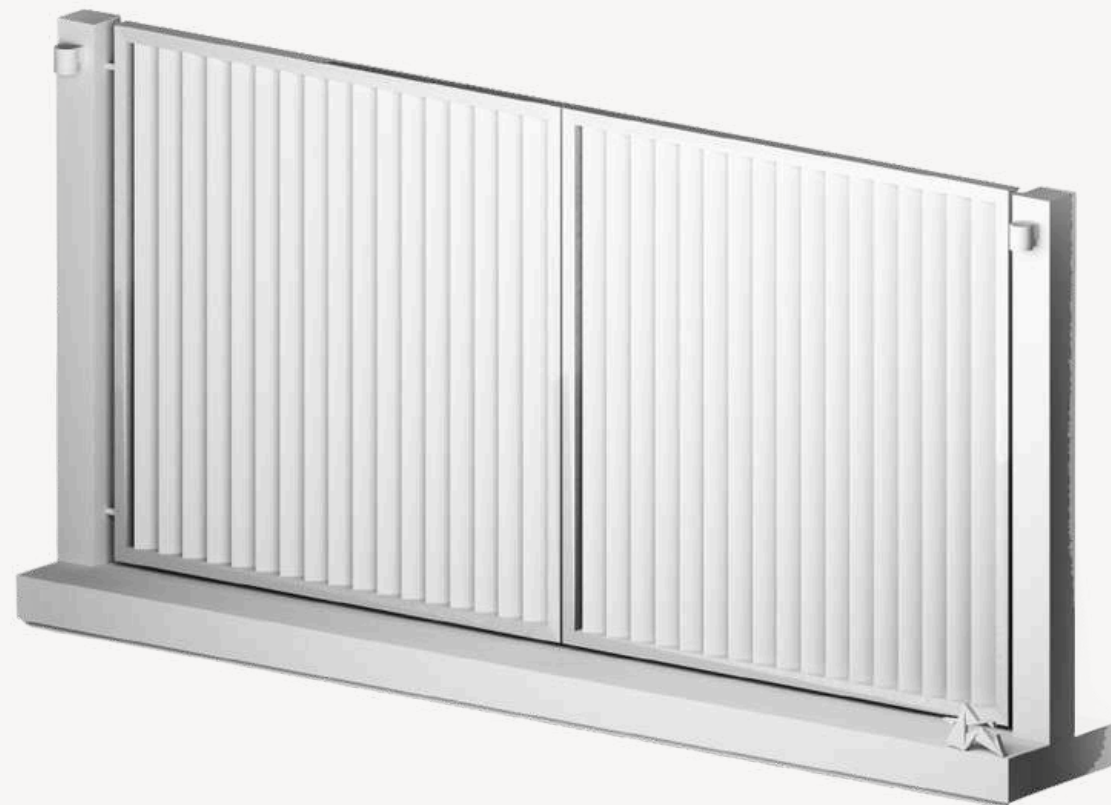

Standard: 3" x 3" and 4" x 4"

Privacy Panel/Gate Height	Post Height	Post Thickness
7"	84" long	.125 Wall
8"	96" long	.125 Wall
9"	108" long	.125 Wall
10"	120" long	.125 Wall
11"	132" long	.125 Wall

Flanged: 3" x 3" and 4" x 4"

Privacy Panel/Gate Height	Post Height	Post Thickness
7"	51" long	.125 Wall
8"	63" long	.125 Wall
9"	75" long	.125 Wall





Other

Strong, Stylish & Secure



At BedRock Metals, we deliver premium aluminum products that combine unmatched strength, sleek design, and reliable security. Engineered with advanced fabrication techniques and crafted from sustainable materials, our products not only stand the test of time but also minimize environmental impact. We are committed to providing cost-effective solutions that maximize value without compromising quality or durability. With BedRock Metals, you get the perfect balance of innovation, sustainability, and affordability — transforming the aluminum fabrication industry for a better future.

Other

Other

Available in several sizes.



Bridging Bar



RC Channel



Metal Studs

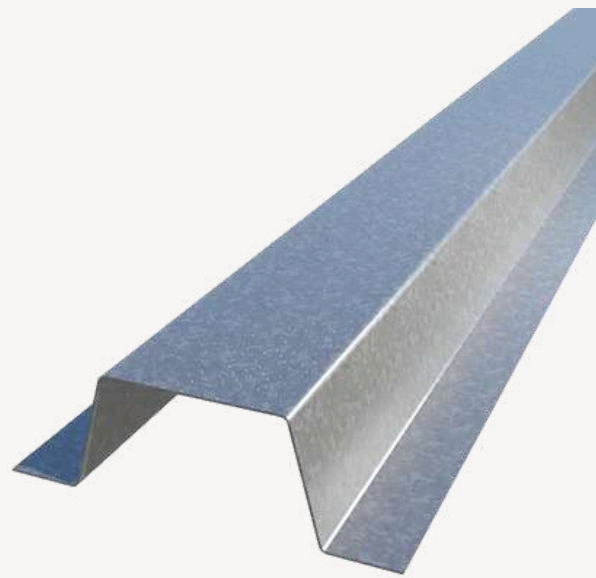

Hat Channel



Metal Track



Trim



Wood Blocking





BedRock

Sales@BedRockMetals.com

BedRockMetals.com

+1 (561) 929 - 5244